

HP 9800 Computers

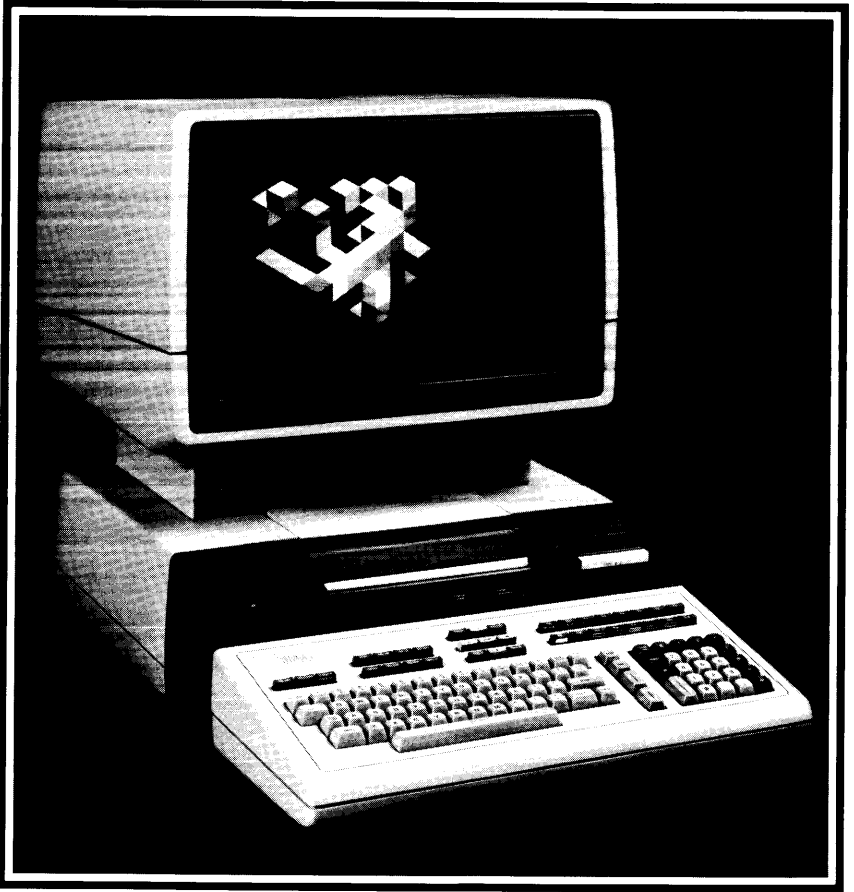

# 98750 CE Handbook



Part No. 98750-90039  
E0982  
Requires Binder No. 9282-0683

Printed in U.S.A.  
First Edition, September 1982

# 98750 CE Handbook

© Copyright Hewlett-Packard Company, 1982

This document refers to proprietary computer software which is protected by copyright. All rights are reserved. Copying or other reproduction of this program except for archival purposes is prohibited without the prior written consent of Hewlett-Packard Company.

**Hewlett-Packard Company**  
3404 East Harmony Road, Fort Collins, Colorado 80525

Chapter 1  
98750 Product Information

Chapter 2  
98750 Environmental Installation/PM

Chapter 3  
98750 Configuration

Chapter 4  
98750 Troubleshooting

Chapter 5  
98750 Diagnostics

Chapter 6  
98750 Adjustments

Chapter 7  
98750 Peripherals

Chapter 8  
98750 Replacement Parts

Chapter 9  
98750 Diagrams

Chapter 10  
98750 Reference

Chapter 11  
98750 Service Notes



# Chapter 1

## Product Information

### CRT Display Specifications

Screen Size:	261 mm x 193 mm (10.3 x 7.6 inches)
Refresh Rate:	60Hz
CRT Phosphor:	P31
Alpha Raster:	236 mm x 123 mm (9.3 x 4.84 inches)
Character Size:	2.3 mm x 2.95 mm (.09 x .116 inches)
Screen Capacity:	24 lines of 80 characters
Graphics Raster:	200 mm x 162.5 mm (7.9 x 6.4 inches)

### Options and Configurations

The 98750A is available as an integral part of the 9845B #1xx. See the 9845B Base CE Handbook Chapter for option information.

### Related Documentation

09845-92030	Service Manual
09845-93050	Monochromatic Graphics Programming Manual
09845-92005	Owner's and System Exerciser Manual

### Product Support Package

The 98750A service tools are included in the 9845B Product Support Package. Refer to the 9845B CE Handbook Chapter.

### Safety

---

**WARNING**

LETHAL VOLTAGES ARE PRESENT INSIDE THE 98750A. REFER TO THE GENERAL SAFETY GUIDELINES IN THE 9845B SERVICE MANUAL.

---



# Chapter 2

## Environmental/Installation/ Preventive Maintenance

### Installation

After unpacking the computer, the CRT assembly must be mounted onto the mainframe assembly. The CRT assembly will lock into place on top of the mainframe support legs. It is important that the guides on the CRT assembly and the mainframe support legs are aligned properly before assembly. Figure 2-1 shows the proper alignment necessary for the CRT assembly installation. Notice how the buttons on bottom of the CRT assembly align with the notches in the support legs.

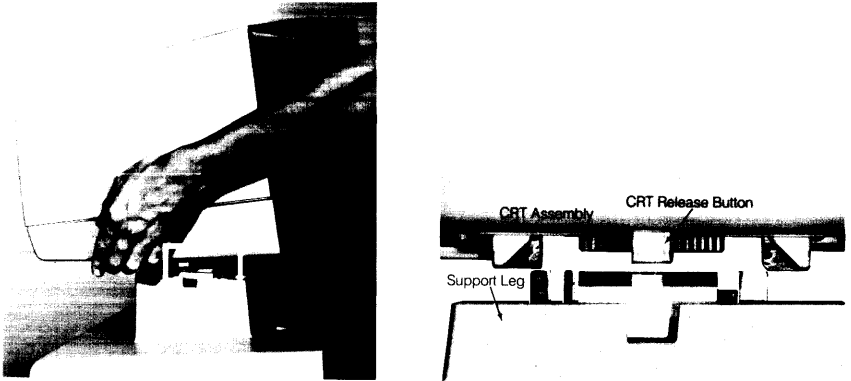

Figure 2-1. CRT Assembly Installation

## **Preventive Maintenance**

Clean the case parts and tube face occasionally with mild soap and water or alcohol. Do not use harsh, abrasive, or other general purpose cleaners.



# Chapter 3

## Configuration

### Base Configuration

The following assemblies must be installed in the 9845B base to support the 98750A.

09845-65517	Graphics ROM
1818-0831	Mainframe ROM for Graphics ROM
and 1818-0835	Mainframe ROM for Graphics ROM
09845-66503	Alpha Control Assembly

Refer to the 9845B Base CE Handbook Chapter for the locations of these parts.

### Interfacing

The 98750A interfaces to the 9845B base via the Alpha Control Assembly (09845-66503) and the Graphics Interface Assembly (09845-66504). Alpha information is stored in block 0 read-write memory, and is refreshed to the display via the IDA bus. Graphics information is transferred via the I/O bus to the display, where it is interpreted and entered into the display memory.

# Status Word

The Status Word may be obtained by executing the following instructions:

```
STATUS 13 ;A  
DISP A
```

The result is a decimal integer which may be converted to binary and interpreted as shown below.

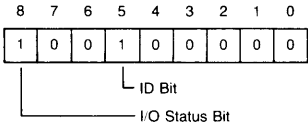

# Chapter 4

## Troubleshooting

### Initial Checks

Check	Action
Is the base operating? (Try PRINTER IS 0 PRINT "HELLO")	Yes - Proceed with Initial Checks. No - Fix base.
Is there any display?	Yes - Proceed to Diagnostics. No - Proceed with Initial Checks.
Adjust intensity control. Press control-stop. Is there a cursor?	Yes - Proceed to Diagnostics. No - Proceed with Initial Checks.
Press A76 Test Button. Does a raster appear?	Yes - Fault in Base.Motherboard.A72 No - Fault in A73.A74.A75.CRT/Yoke



# Chapter 5

## Diagnostics

### Test Summary

The CRT Tests are contained on the 9845B Test Binary Cartridge or the 9845A Test ROM. For the 9845B, insert the cartridge, and enter:

```
LOADBIN "TBIN"
```

For the 9845A, install the Test ROM and turn power on.

Press k0 for the CRT alpha tests or k5 for the CRT Graphics tests. Follow the instructions for each test, as follows.

#### K0 CRT Alpha Test

This test will check and exercise all the CRT alpha functions and provide test patterns for the following CRT adjustments:

- Focus
- Alpha raster size

The adjustment procedures are found after this test procedure.

To exit this test press **STOP**.

Press **k0**; the CRT displays:

```
Press B For full buffer
      H For He He
      L For Linearity
      G Graphics
      C For Character Set
      O For Optional Char. Set
      F For Features
```

## 5-2 98750 Diagnostics

Press **B** ; the CRT displays:

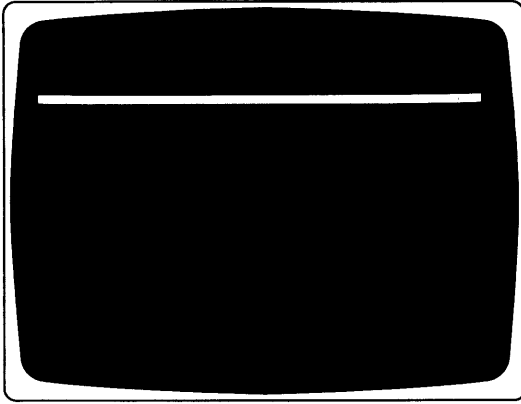

A failure on this display indicates a probable A73 assembly failure.

Press **H** ; the CRT displays:

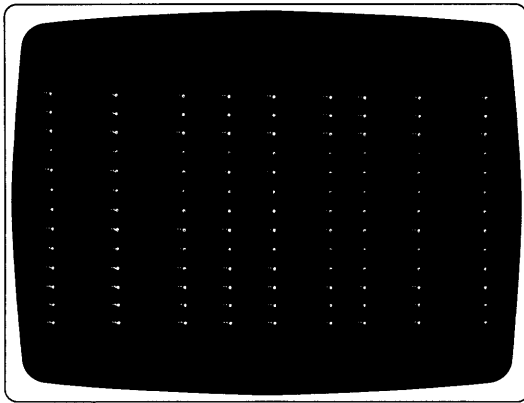

Use this pattern to adjust the focusing adjustment (described after this test) until the "H" characters are sharp and clear. The focus control is on the A75 assembly.

Press **L** : the CRT displays:

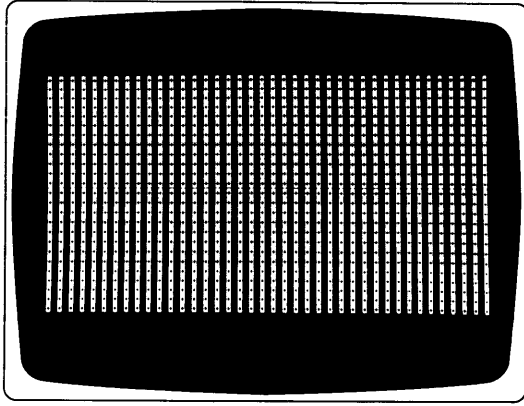

Press **G** : if the graphics option is installed, a full screen graphics cursor is displayed and the computer is in the graphics mode. See the Graphics section for details.

Press **STOP** to exit the graphics test and return to the CRT Alpha Test.

If the graphics option is not installed, the G key will be ignored.

Press **C** : the CRT displays:

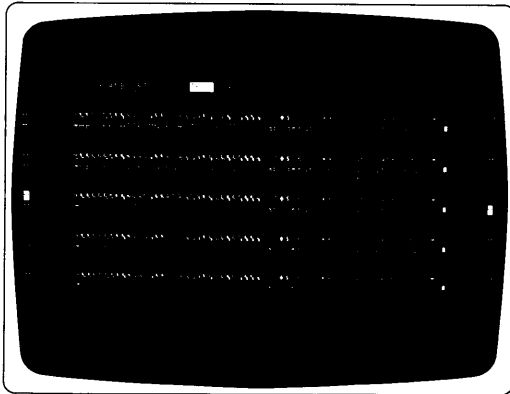

## 5-4 98750 Diagnostics

The character set is repeated five times. This test exercises all the CRT features. If the pattern is deformed, the A73 assembly may be defective.

Press **0** : the CRT displays the optional characters if the option ROM is installed. When the option ROM is not installed the CRT shows:

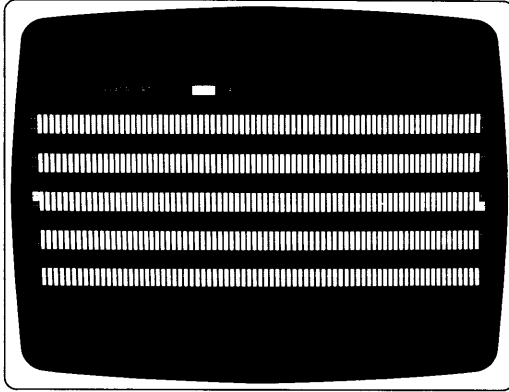

Press **F** : all the CRT display features can now be checked. The CRT displays:

PRESS CONTINUE

Press **CONTINUE** 15 times, noting each time the feature being displayed. The features are shown in the following order.

- inverse video
- normal blinking video
- normal video underlined
- normal video with cursor
- blinking inverse video
- underlined inverse video
- inverse video with cursor
- blinking inverse video underlined
- inverse video with underline and cursor
- blinking inverse video with cursor
- blinking inverse video with underline and cursor
- blinking video and underline
- blinking video and and cursor
- blinking video cursor and underline
- normal video cursor and underline



## K5 CRT Graphics Test

This test checks the 32k-byte graphics memory and tests all the CRT graphics commands.

Press ( **ks** ), the graphics memory test runs automatically. The test lasts about one minute. To exit the graphics memory test before it is completed, press ( **CONTINUE** ). Errors in the graphics memory test are displayed, for example:

GRAPHICS (octal address) HAS (octal pattern) NOT (octal pattern)

When the graphics memory test is completed manual control of the cursor and display is enabled. Here is a description of the control features and the key to press for each feature.

- ( **←** ) Moves the cursor to the left.
- ( **→** ) Moves the cursor to the right.
- ( **↑** ) Moves the cursor up.
- ( **↓** ) Moves the cursor down.

---

### Note

Pressing the above keys once moves the cursor one step. Pressing the keys all the way down moves the cursor ten steps at a time.

---

- ( **B** ) A box outlining the graphics raster is displayed.
- ( **C** ) Causes three different cursors to appear. One type is displayed each time ( **C** ) is pressed. Press ( **C** ) three times to view the cursors listed below.  
The alpha cursor ( - ).  
The graphics cursor ( + ).  
The full screen graphics cursor.
- ( **E** ) Clears the display. Pressing ( **SHIFT** ) at the same time clears the display faster.
- ( **F** ) Fills the entire display with dots.
- ( **G** ) Displays grid referenced from the current X, Y position of the cursor.
- ( **L** ) Causes any function being performed to loop or be performed continuously until ( **L** ) is pressed again.
- ( **P** ) Displays the cursor position on the display and the corresponding position in memory. To continue press another key.
- ( **R** ) Random pattern check.
- ( **S** ) Skip a particular test. (exits the graphics test)
- ( **STOP** ) Exits the graphics memory test.
- ( **T** ) Begins the graphics memory test.
- ( **W** ) Walking bit test.
- ( **X** ) Places the cursor in the center of the display. ( **SHIFT** ) ( **X** ) moves the cursor off the display.

Press any key to continue after an error occurs.

To exit the test, press ( **STOP** ) once to stop the operation then press ( **STOP** ) again to exit the graphics test.



# Chapter 6

## Adjustments

### CRT Display Focus

The focus should be checked whenever the A75 or the CRT/yoke assembly has been changed.

The focus control is located on the A75 assembly inside the high voltage cage. Remove the CRT top cover and the high voltage cage cover to access the A75 assembly (see Figure 6-1).

Display a full raster pattern of characters; the test ROM CRT alpha test will provide these patterns. Adjust the focus control to sharpen the appearance of the displayed characters. It may not be possible to focus all areas of the display at a particular control setting; in this case, the focus control should be set at the point that gives the best overall display appearance.

### CRT Intensity

The intensity should be checked whenever the A75 or the CRT/yoke assembly has been changed.

The intensity control is located on the A75 assembly inside the high voltage cage. Remove the CRT top cover and the high voltage cage cover to access the A75 assembly (see Figure 6-1).

To adjust the CRT intensity, use the following procedure.

1. Advance the A75 intensity control and the operator's intensity control on the lower right corner of the CRT bezel to maximum intensity.
2. With both controls at maximum settings, horizontal retraces should appear on the CRT. Adjust the A75 intensity control until the retraces are no longer visible.
3. Press the CRT test button and notice the intensity of the full raster display.
4. Use the A75 intensity control to reduce this intensity by approximately  $\frac{1}{2}$ . This control setting is between  $\frac{1}{8}$  and  $\frac{1}{4}$  of a turn less on the A75 intensity control.
5. Adjust the operator's intensity control for the desired intensity.
6. Reassemble the computer.

### CRT Alpha Raster Size

The alpha raster size should be checked whenever one of the CRT section assemblies has been changed. To adjust the alpha raster, use this procedure.

- Remove the CRT top cover.
- Press the CRT test button on the A73 assembly, shown in Figure 6-1, to display the alpha raster in inverse video.
- Use the alpha width and alpha height controls on the A74 assembly to adjust the edges of the inverse video. Use the raster dimensions given in the Specifications in Chapter 1.

## CRT Graphics Raster Size

To adjust the graphics raster use this procedure:

- Remove the CRT top cover.
- Install the test binary cartridge and switch the power switch to on.
- Answer the questions and press k5 when its time to select a function key.
- Use the graphic width and graphic height controls on the A74 assembly to align the edges of the inverse video to the graphics raster outline on the CRT alignment mask. Use the raster dimensions given in the specifications in chapter 1.

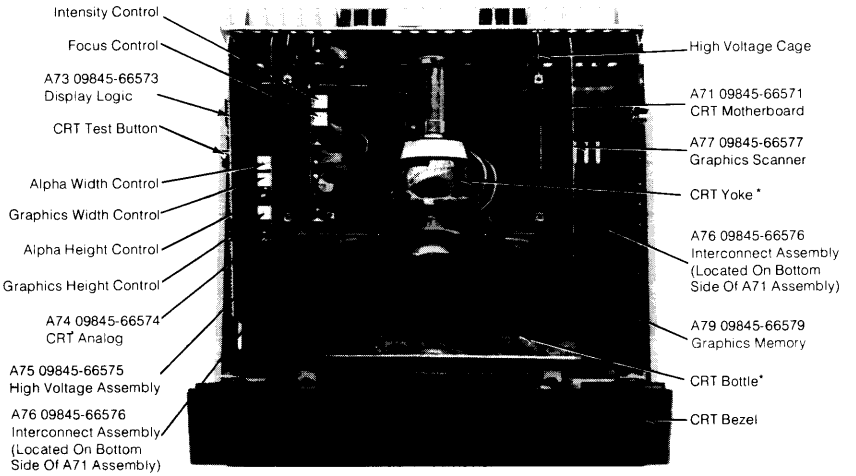

\*CRT and Yoke are one Assembly (09845-67160)

Figure 6-1

# Chapter 7

## Peripherals



# Chapter 8

## Replaceable Parts

### Repair Philosophy

Most 98750A repairs are done by replacing the faulty assembly. The old assembly is returned for repair in some cases (exchange program) and is thrown away in others. In a few cases, a faulty assembly can be repaired to the component level either on-site or at the local field office. This procedure is recommended only when replaceable components are not soldered in or when the probability of inducing further damage in the course of doing the repair is minimal. All components which may be replaced by the CE are listed as level 2 parts under the assembly part number in the parts lists. Other failures should be repaired at the assembly level. All exchange parts are noted as such in the parts lists.

**Table 1: Replaceable Parts List**

Assembly Level	Reference Designator	CD	HP Part No.	TQ	Description
1		6	0960-0480	1	Tripler
1		4	09845-26576	2	CRT Interface PC board
1		4	09845-61671	1	Intensity Control Cable
1		5	09845-61672	1	Tube Socket Cable
1	A71	3	09845-66571	1	Motherboard
1	A72	4	09845-66572	1	Power Transistor Assy.
2	Q4	5	1826-0169	1	Voltage Regulator - LM320K-15
2	Q1	8	1826-0203	1	Voltage Regulator - 7815KC
2	Q2,3	8	1853-0305	2	Transistor - 2N5875
2	Q6	7	1854-0518	1	Transistor - 2N5877
2	Q5	8	1854-0783	1	Transistor - 2N6583
1	A73	5	09845-66573	1	Display Logic Assy. - New
		1	09845-69573		Display Logic Assy. - Exchange
1	A74	6	09845-66574	1	CRT Analog Assy. - New
		2	09845-69574		CRT Analog Assy. - Exchange
1	A75	7	09845-66575	1	High Voltage Assy. - New
		3	09845-69575		High Voltage Assy. - Exchange
1	A77	9	09845-66577	1	Graphics Scanner Assy. - New
		5	09845-69577		Graphics Scanner Assy. - Exchange
1	A79	1	09845-66579	1	Graphics Control Assy. - New
		7	09845-69579		Graphics Control Assy. - Exchange
1		0	09845-67972	1	CRT Yoke Assy.

## 8-2 98750 Replacement Parts



# Chapter 9

## Diagrams

### CRT Section (Alpha)

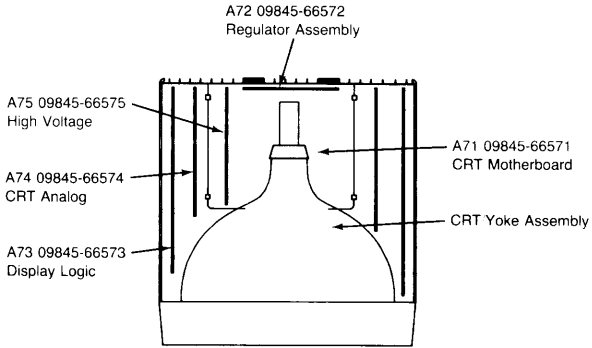

### Graphics Section

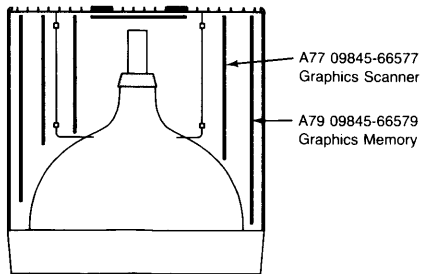



Graphics Block Diagram

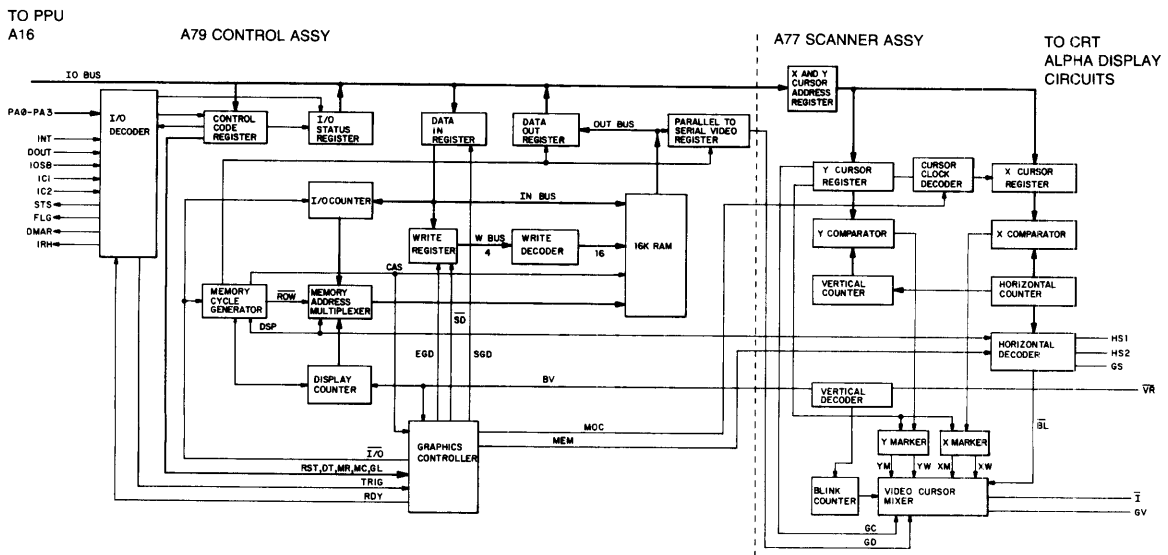

View From Inside The Rear Panel.

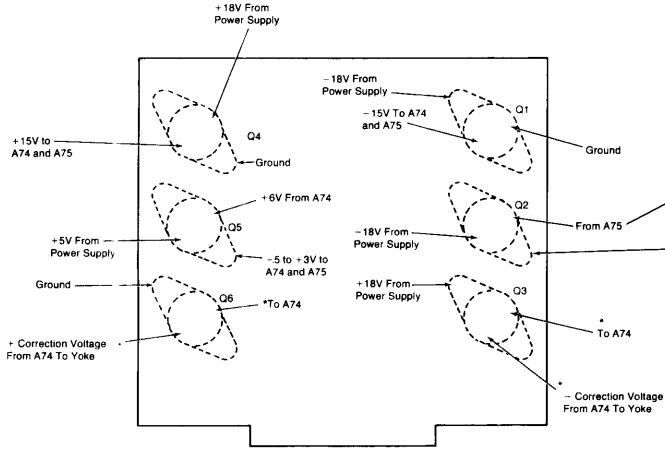

- Q4 +15V Regulator
- Q5 B + Regulator Pass Transistor
- Q6 Horizontal Correction Amplifier (- Swing)
- Q1 -15V Regulator
- Q2 HV Switching Transistor
- Q3 Horizontal Correction Amplifier (+ Swing)

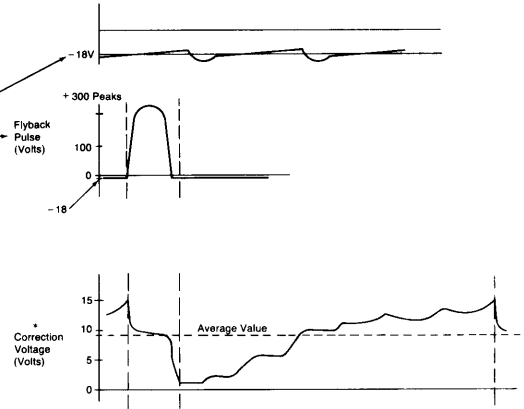

# Chapter 10

## Reference



# Chapter 11

## Service Notes

